

THIRD SEMESTER B.TECH DEGREE EXAMINATION

(2013 Scheme)

13.301 ENGINEERING MATHEMATICS-II (ABCEFHMNPRSTU)

MODEL QUESTION PAPER

Time: 3 hours

Maximum marks: 100

PART-A

Answer all questions. Each question carries 4 marks

1. A particle moves so that its position vector is given by

$\vec{r} = \cos wt \hat{i} + \sin wt \hat{j}$, show that the velocity \vec{V} of the particle is perpendicular to \vec{r} .

2. If $f(x) = x$, $0 < x < \frac{\pi}{2}$

$= \pi - x$, $\frac{\pi}{2} < x < \pi$. Show that $f(x) = \frac{4}{\pi} \left(\sin x - \frac{\sin 3x}{3^2} + \frac{\sin 5x}{5^2} - \dots \right)$

3. Find the cosine transform of $f(x) = \sin x$ in $0 < x < \pi$.

4. Solve the partial differential equation if $\frac{\partial z}{\partial x} = 6x + 3y$; $\frac{\partial z}{\partial y} = 3x - 4y$.

5. State the assumptions involved in the derivation of one dimensional Heat equation.

PART-B

Answer one full question from each module. Each question carries 20 marks.

MODULE-I

6. a) Find the constants a and b so that the surfaces $5x^2 - 2yz - 9x = 0$ and $ax^2y + bz^3 = 4$, may cut orthogonally at the point $(1, -1, 2)$.
- b) If φ is a scalar point function, use Stoke's theorem to prove that $\text{Curl}(\text{grad } \varphi) = 0$.
- c) Evaluate by Green's theorem in the plane for $\int_C (y - \sin x)dx + \cos x dy$ where C is the boundary of the triangle whose vertices are $(0,0)$, $(\frac{\pi}{2}, 0)$ and $(\frac{\pi}{2}, 1)$.
7. a) If $\vec{r} = x \hat{i} + y \hat{j} + z \hat{k}$ prove that $\nabla r^n = nr^{n-2} \vec{r}$ where $r = |\vec{r}|$.
- b) Show that $\vec{F} = e^x[(2y + 3z)\hat{i} + 2\hat{j} + 3\hat{k}]$ is irrotational and find its scalar potential.
- c) Using divergence theorem, evaluate $\iint_S \vec{F} \cdot \hat{n} ds$ where $\vec{F} = 4x\hat{i} - 2y^2\hat{j} + z^2\hat{k}$ and S is the surface bounding $x^2 + y^2 = 4$, $z = 0$ and $z = 3$

MODULE-II

8. a) Obtain the Fourier series of the function $f(x) = \left(\frac{\pi-x}{2}\right)^2$ in $(0, 2\pi)$

b) Find the Fourier transform of $f(x) = 1, |x| < a$
 $= 0, |x| \geq a$

Hence evaluate $\int_0^{\infty} \frac{\sin x}{x} dx$

9. a) Find the Fourier series of $f(x) = -x + 1, -\pi \leq x \leq 0$

$= x + 1, 0 \leq x \leq \pi$

b) Find the Fourier cosine transform of $f(x) = e^{-4x}$ and

hence show that $\int_0^{\infty} \frac{\cos 2x}{x^2+16} dx = \frac{\pi}{8} e^{-8}$

MODULE-III

10. a) Solve the pde $pxy + pq + qy = yz$.

b) Solve the pde $(D^2 - DD' + 2D'^2)z = e^{3x+4y} + \sin(x-y)$

11. a) Solve the partial differential equation $x(y^2 - z^2)p - y(z^2 + x^2)q = z(x^2 + y^2)$

b) Solve the pde $(D^2 + DD' - 6D'^2)z = y \cos x$

MODULE-IV

12. a) Using the method of separation of variables, solve $\frac{\partial u}{\partial x} - 2\frac{\partial u}{\partial t} = u$ given that

$u = 3e^{-5x} + 2e^{-3x}$ when $t = 0$.

b) A string of length l is fixed at both the ends. The midpoint of the string is taken to a height b and then released from rest in that position. Find the displacement of the string.

13. a) Solve $\frac{\partial u}{\partial t} = \alpha^2 \frac{\partial^2 u}{\partial x^2}$ subject to the condition, $u(0, t) = 0 = u(\pi, t)$ and

$u(x, 0) = \pi x - x^2$ in $(0, \pi)$

b) A rod of length l has its ends A and B kept at $0^\circ C$ and $100^\circ C$ respectively until steady conditions prevail. The temperature at A is suddenly raised to $25^\circ C$ and at the same time that B is lowered to $75^\circ C$ and the end temperatures are thereafter maintained. Find the temperature function $U(x, t)$.

THIRD SEMESTER B.TECH DEGREE EXAMINATION

(2013Scheme)

13.302 HUMANITIES (BEFMRSU)

MODEL QUESTION PAPER

Time: 3Hours

Max. Marks: 100

Instructions: Answer Part-I and Part-II in separate Answer Books.

PART-I (Economics)

Time: 2 hrs

Max. Marks: 70

PART-A

Answer all questions. Each question carries 2 marks.

1. Distinguish between Producer good and consumer good.
2. Define production function.
3. Give an example of diminishing returns to scale.
4. Who is an entrepreneur?
5. Define the concept of Marginal Product.
6. What is meant by 'reserve requirement' by banks?
7. Name the methods of measuring National Income.
8. What is stagflation?
9. List out two reasons for Privatisation.
10. Define the concept of Poverty. (2 x10= 20 marks)

PART-B

Answer any one full question from each Module. Each full question carries 25 Marks

MODULE - I

11. What are the Central problems of an economy? Why do they arise? Do all economies have identical Central Problems?

OR

12. Explain the Law of variable proportion and Law of Returns to Scale.

MODULE - II

13. Explain the different concepts related to National Income calculation. Explain the sectoral distribution of National Income in India and what are the issues associated to it.

OR

14. a) Discuss the impact of multinational companies in Indian Economy.
b) Discuss the impact of globalization on Telecom and Financial sector.

PART-II (Accountancy)

Time: 1 hr

Max. Marks: 30

Answer any two questions. Each question carries 15 marks.

1. Explain the concepts and conventions of accountancy.
2. (a) What are journal accounts? Explain the rules for journalizing.
(b) Briefly explain the accounting package.
3. Based on the following trial balance prepare a profit and loss account and a balance sheet.

The following is the trial balance of Mr. Alex as on 31st December, 2013.

	Dr (Rs)	Cr (Rs)
Plant and machinery	45,000	
Freehold premises	55,000	
Stock 1 st January 2006	36,500	
Salaries	7,600	
Purchases	65,000	
Sales		1,21,000
Furniture and fitting	6,000	
Carriage inwards	1,675	
Carriage outwards	1,315	
Sales returns	2,400	
Purchases returns		1,365
Discount received		635
Discount allowed	430	
Wages	16,100	
Sundry debtors	41,000	
Sundry creditors		28,800
Alex's capital		1,10,000
Rent, rates and taxes	1,430	
Advertisement	2,400	
Cash in hand	450	
Cash at bank	2,500	
Drawings	3,000	
Loan from Rajesh		26,000
Total	2,87,800	2,87,800

THIRD SEMESTER B.TECH DEGREE EXAMINATION

(2013Scheme)

13.303 AUTO CHASSIS (U)

MODEL QUESTION PAPER

Time: 3Hours

Max. Marks: 100

PART-A

Answer all questions. Each question carries 2 marks.

1. Mention the advantages of four wheel steering over conventional steering system?
2. What do you mean by antiroll bars?
3. What are the characteristics of propeller shaft?
4. State the characteristics of coil spring suspension system.
5. What do you mean by scrub radius?
6. What do you mean by turning circle radius?
7. What do you mean by Torque reaction?
8. How do you specify a tyre?
9. Compare conventional tubed tyre and tubeless tyre.
10. State the advantages of disc brake over drum brakes. (2 x10= 20 marks)

PART-B

Answer any one full question from each Module. Each full question carries 20 Marks

MODULE I

11. (a) State the advantages and disadvantages of (i) front engine front wheel drive (ii) front engine rear wheel drive.
(b) With neat sketches explain various types of frames used in automobiles.
12. (a) What are the common defects occurring in the frames?
(b) What are the possible reasons for misalignment in frames? Mention various methods to find it.

(c) What are the main functions of an automobile frame?

MODULE II

- 13.** With the help of neat sketches explain various wheel alignment parameters used in automobiles. Also mention its effect on the vehicle.
- 14.** Explain the constructional features of air suspension system. Briefly explain the details of air springs used in such suspension systems.

MODULE III

- 15.** (a) Explain the constructional features of a differential.
(b) What do you mean by limited slip differential?
(c) What are the characteristics of Hotchkiss drive?
- 16.** (a) What do you mean by static and dynamic balance of tyres?
(b) Discuss the characteristics of tubeless tyres stating its advantages over tubed tyres.

MODULE IV

- 17.** (a) With the help of a neat sketch explain vacuum servo brakes.
(b) Explain with neat sketches the fail safe air brakes used in automobiles.
- 18.** (a) What are the requirements of a braking system?
(b) What do you mean by ABS?
(c) Explain the constructional features of a wheel cylinder.

THIRD SEMESTER BTECH DEGREE EXAMINATION

(SCHEME: 2013)

13.304 MECHANICS OF SOLIDS (MNPSU)

MODEL QUESTION PAPER

Time: 3 hours

Maximum marks: 100

PART-A

Answer all questions. Each question carries 4 marks

1. Define elastic constants.
2. Define thermal stress and derive an expression for the stress developed in a bar restrained at both ends subjected to an increase in temperature.
3. Define Principal stress and principal planes.
4. What is meant by pure torsion. Write down torsion equation and explain the terms.
5. Differentiate between short and long column. (5 × 4 Marks = 20 Marks)

PART-B

Answer one full question from each module. Each question carries 20 marks.

MODULE-I

6. (a) Explain the principle of superposition to evaluate total strain of axially loaded bars. (5)
(b) A bar of uniform cross sectional area 100mm^2 carries forces in Newton as shown in fig. Calculate the relative movement of end A with respect to D. Take $E=200\text{GPa}$. (15)

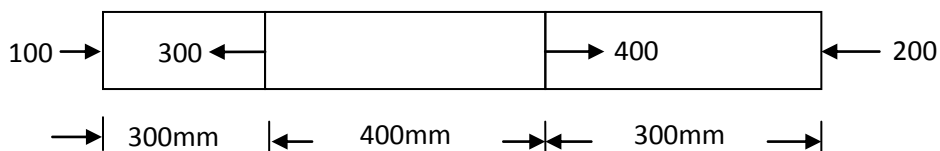

7. A rigid cross bar is supported horizontally by two vertical bars, A and B of equal lengths and hanging from their tops. The bars A and B are 0.6m apart. The cross bars stays horizontal even after a vertical force of 6kN is applied to it at a point 0.4m from B. If the stress in A is 200 MPa, find the stress in B and the area of cross section of the two rods. $E_A=200\text{ GPa}$, $E_B=130\text{ GPa}$. (20)

MODULE II

8. Compare the strain energy stored in the bar A with that of bar B ,when the maximum stress produced in both bars is the same. (20)

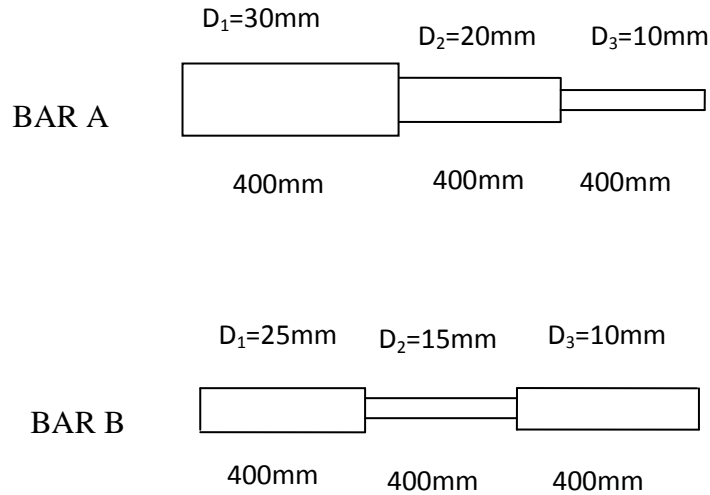

9. Determine the principal stresses and principal planes in an element subjected to stresses as shown in figure below. Also calculate i) Maximum shear stress and its plane ii) Stress conditions in the plane shown. (20)

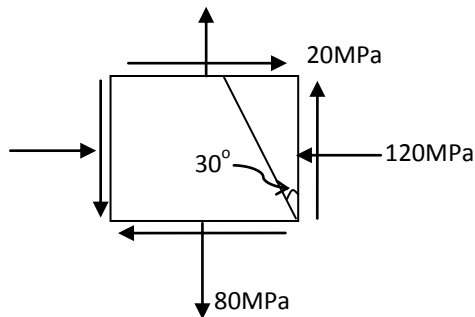

MODULE III

10. Draw shear force and bending moment diagram for the beam shown in figure and mark the salient points. What is the maximum bending stress produced in the beam? The cross section of the beam is hollow rectangular with 150x300mm external and thickness 25mm. (20)

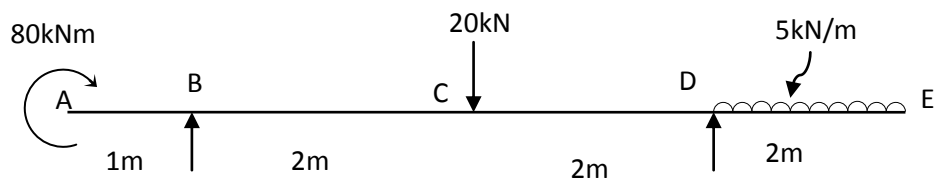

11. Calculate the maximum deflection and maximum slope for the beam shown in fig. below.

(20)

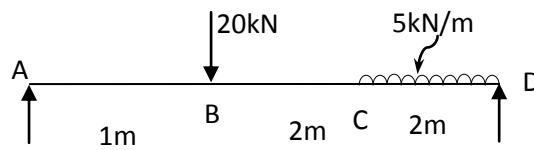

MODULE IV

12. a) Determine the diameter of the hollow shaft which will transmit 100 kW at 200 rpm if the shear stress is limited to 60 MPa. Take diameter ratio 0.6. (10)

b) Analyse the truss given below by method of joints. (10)

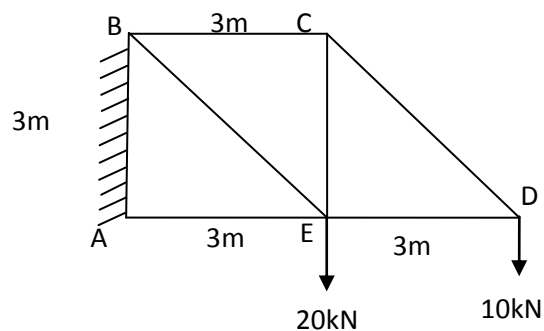

13. a) A hollow rectangular column of external depth 1000mm and external width 800mm is 100mm thick. Calculate the maximum and minimum stresses in the section if load of 200kN is acting with an eccentricity of 150mm wrt YY axis. (10)

b) Determine the buckling load for a strut of T-section, the flange width being 150mm, overall depth 100mm and both flange and web 13mm thick. The strut is 3m long and is hinged at both ends. Take $E = 200$ GPa. (10)

THIRD SEMESTER B.TECH DEGREE EXAMINATION (2013Scheme)

Branch: Mechanical – Stream – Automobile Engineering

13.306 MACHINES AND AUTO COMPONENT DRAWING (U)

MODEL QUESTION PAPER

Time: 3Hours

Max. Marks: 100

Instructions: Use First Angle projection. Assume any missing data suitably.

PART-A

Answer all questions. Each question carries 10 marks.

1. Draw the three views of M30 hexagonal bolt showing all dimensions in terms of bolt diameter.
2. Dimensions of a hole and its mating shaft are given below, according to the basic hole system.

Hole: 27.500mm

Shaft: 27.470mm

27.575mm

27.445mm

Find the values of the hole tolerance, shaft tolerance and clearances, and represent these dimensions graphically.

3. Draw the circuit diagram of an ignition system used in automobiles.
4. Draw the layout of a fully equipped modern garage. (4 x 10 = 40 marks)

PART-B

Answer any one full question. Each full question carries 60 Marks

5. Assemble the following components suitably and draw the top sectional front view and top view.

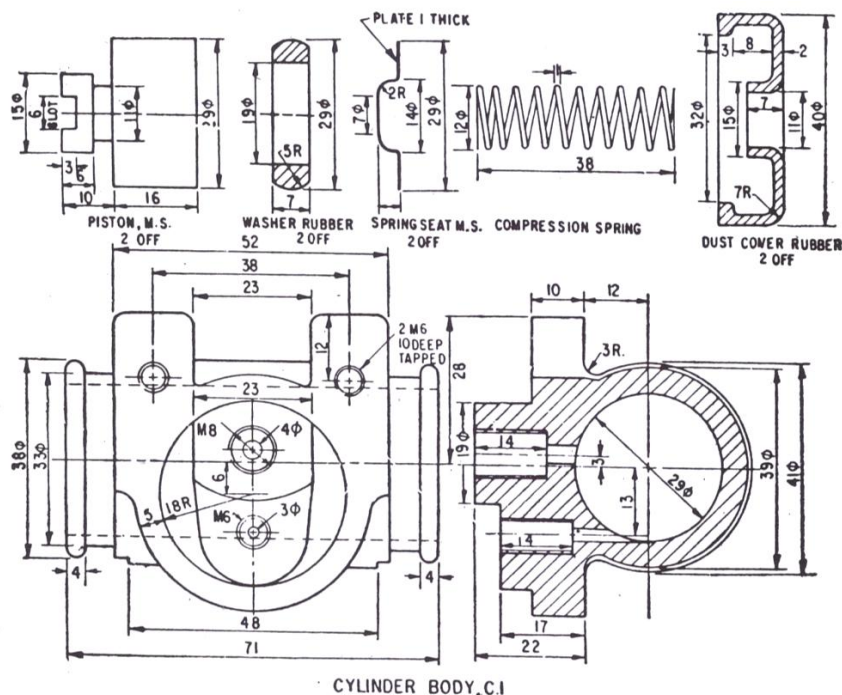

6. Assemble the following machine components suitably and draw the sectional front view and right side view.

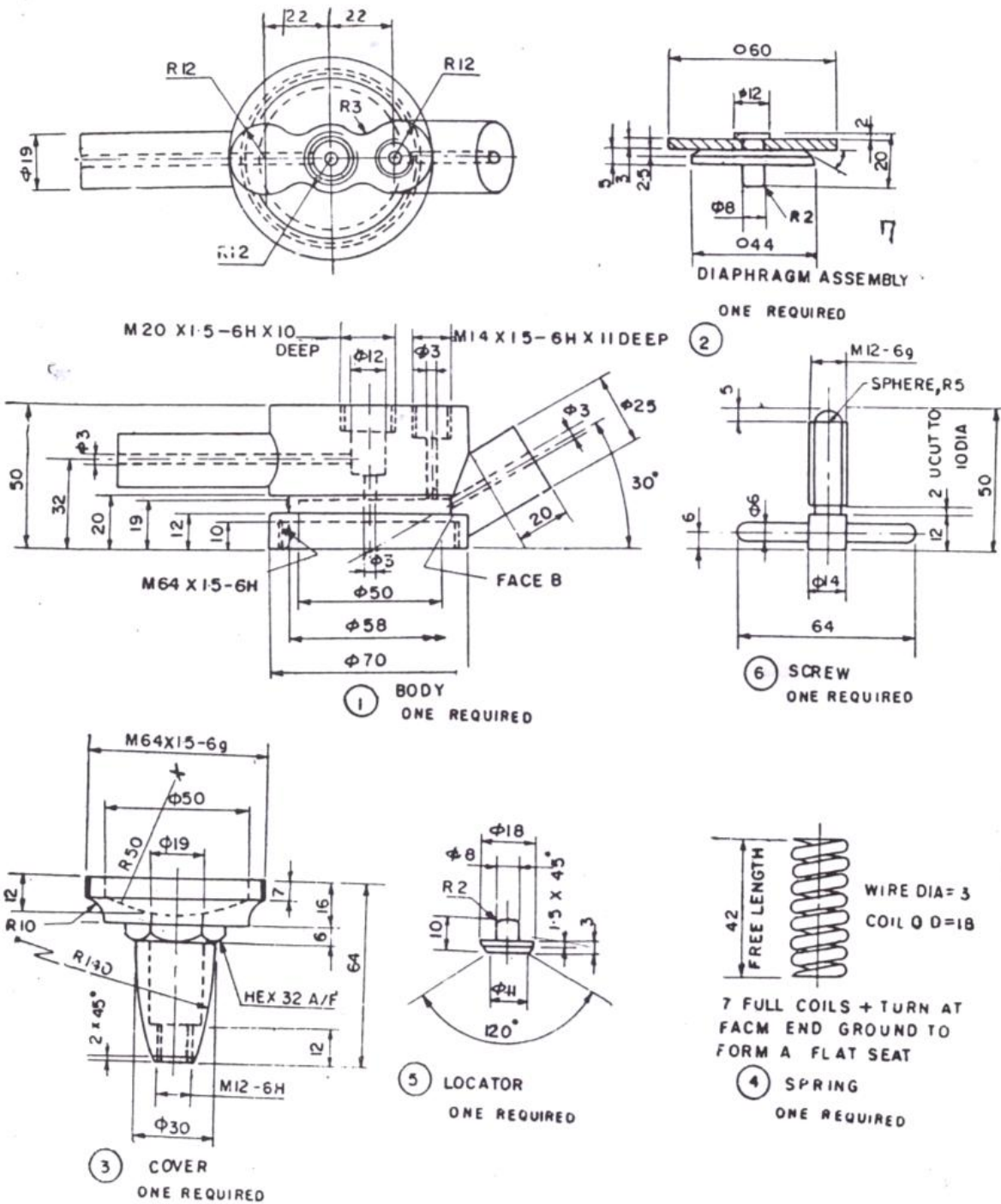

THIRD SEMESTER B. TECH. DEGREE EXAMINATION

(2013 Scheme)

13.307 THERMAL ENGINEERING (MU)

MODEL QUESTION PAPER

Time : 3 Hours

Max. Marks : 100

Instructions: Use of approved Steam Tables permitted.

PART –A

Answer all questions. Each question carries 2 Marks.

1. What is the necessity of adopting 'Binary vapor cycle'? Explain briefly.
2. Define the term "Degree of Reaction".
3. What do you mean by compounding of steam turbine?
4. What is the effect of cut-off ratio on the efficiency of diesel cycle when the compression ratio is kept constant?
5. List the merits and demerits of two stroke engines over four stroke engine.
6. For the same maximum pressure and temperature of the cycle and the same heat rejection, which cycle is more efficient: Otto or Diesel? Explain with the help of $P-v$ and $T-s$ diagrams.
7. What is delay period and what are the factors that affect the delay period.
8. Explain the difference between pre ignition and auto ignition.
9. Explain four characteristics of a gas turbine which would make it advantageous in its selection.
10. Sketch the Brayton cycle on $P-v$ and $T-s$ planes and mention the various processes.

(2x10=20 Marks)

PART – B

Answer any one full question from each Module. Each full question carries 20 Marks

MODULE I

11. a) Explain with the help of a neat sketch the working of a La Mont boiler. *(10 Marks)*

- b) Superheated steam at a pressure of 10 bar and 400°C is supplied to a steam engine. Adiabatic expansion takes place to release point at 0.9 bar and it exhausts into a condenser at 0.3 bar. Neglecting clearance, determine for a steam flow rate of 1.5 kg/s:
- (i) Quality of steam at the end of expansion and the end of constant volume operation.
- (ii) Power developed (iii) specific steam consumption and (iii) Modified Rankine cycle efficiency (10 Marks)
12. a) What do you mean by governing of steam turbine? Explain with neat sketch the various methods of governing. (10 Marks)
- b) The steam enters an impulse wheel having a nozzle angle of 20° at a velocity of 450m/sec. The exit angle of the moving blade is 20° and the relative velocity of the steam may be assumed to remain constant over the moving blades. If the blade speed is 180 m/sec, determine (i) Blade angle at inlet (ii) Work done per kg of steam (iii) Power of the wheel, when the turbine is supplied with 1.8 kg of steam per second. (10 Marks)

MODULE II

13. a) Explain the working of four stroke Diesel engine with the help of suitable sketches . (10 Marks)
- b) A 4-cylinder, 4-stroke, 10 cm x 12cm petrol engine runs at 1500rpm. It has a clearance of 14% of cylinder volume. Its relative, volumetric and mechanical efficiencies are 60%, 85% and 80% respectively. Its air-fuel ratio is 18:1. The calorific value of the fuel is 45 MJ/kg. The inlet conditions are 1 bar and 300 K. Calculate the engine performance. (10 Marks)
14. a) Derive an expression for the efficiency of an air-standard Otto cycle in terms of its compression ratio (10 Marks)
- b) After a test on a single cylinder, 4-stroke oil engine, the following data were recorded. Stroke length = 250 mm; Cylinder bore = 150 mm; Area of the indicator diagram = 450mm^2 ; Length of the indicator diagram = 50 mm; Indicator string rating = 1.2 mm for a pressure of 9.806 N/cm^2 ; Engine speed = 400 rpm; Brake torque = 225 N-m; Fuel consumption = 3 kg/h; Calorific value = 44200 kJ/kg; Cooling water flow rate= 4 kg/min; Rise of temperature for cooling water = 42°C .
- Compute: (i) Mechanical efficiency. (ii) Brake thermal efficiency. (iii) Specific fuel consumption, and (iv) heat balance sheet in kW. (10 Marks)

MODULE III

15. a) Explain the significance of flame speed and its combustion in S.I. engine. (10 Marks)
- b) Explain the phenomena of knocking in SI engine. What are the different factors which influence the knocking? Describe the methods used to suppress it. (10 Marks)
16. a) A fuel ($C_{10}H_{22}$) is burnt using an air-fuel ratio of 13: 1 by weight. Determine the complete volumetric analysis of the products of combustion, assuming that the whole amount of hydrogen burns to form water vapour and there is neither any free oxygen nor any free carbon. The carbon burns to CO_2 and CO . Air contains 77% of nitrogen and 23% of oxygen by weight. (10 Marks)
- b) Explain briefly various methods by which SI engine emission can be controlled. (10 Marks)

MODULE IV

17. a) What are the basic requirements of a gas turbine combustion chamber? With a neat sketch explain the combustion chamber geometry bringing out the various zones that play a part in the process of combustion. (10 Marks)
- b) What are the different methods used to improve the efficiency of a gas turbine plant? Explain any two methods with a neat sketch. (10 Marks)
18. a) Compare between open cycle gas turbine and closed cycle gas turbine. (8 Marks)
- b) The air supplied to a gas turbine plant is 10 kg/s. The pressure ratio is 6 and pressure at the inlet of compressor is 1 bar. The compressor is two -stage and is provided with perfect intercooling. The Inlet temperature is 300K and maximum temperature is limited to 1073K .Take the following data;
- Isentropic efficiency of compressor each stage = 80%
- Isentropic efficiency of turbine = 85%
- A regenerator is included in a plant whose effectiveness is 0.7. Neglecting the mass of fuel, determine the thermal efficiency of the plant.
- Take C_p for air as 1.005kJ/kg. K. (12 Marks)
-